

Dynamic and Cooler

High Efficacy & Lower Thermal Resistance

Duet F300 is a 300W COB series offering 5 different PPFD ratios between 450nm Blue and Broadband 600nm~700nm Red corresponding to various **Plant Grow** stages. Each COB is structured based on patented DBR LED Flip Chips and low temperature bonding technologies to further boost lighting efficacy and decrease the thermal resistance between the LED chip junction and module's metal substrate.

Features:

- 5 Options in Blue/Red Power Ratio
- Peak of Blue Spectrum at 450nm \pm 3nm
- Peak Options of Red Spectrum at 650 \pm 2nm, 640 \pm 2nm, and 627 \pm 2nm
- Red Broadband FWHM \pm 40nm
- 59mm Light Emitting Surface
- 0.1 $^{\circ}$ C/W Thermal Resistance
- Maximum Power 646.4W
- Patented DBR Flip Chips (35x35mil)
- Low Temperature Bonding
- RoHS Compliant

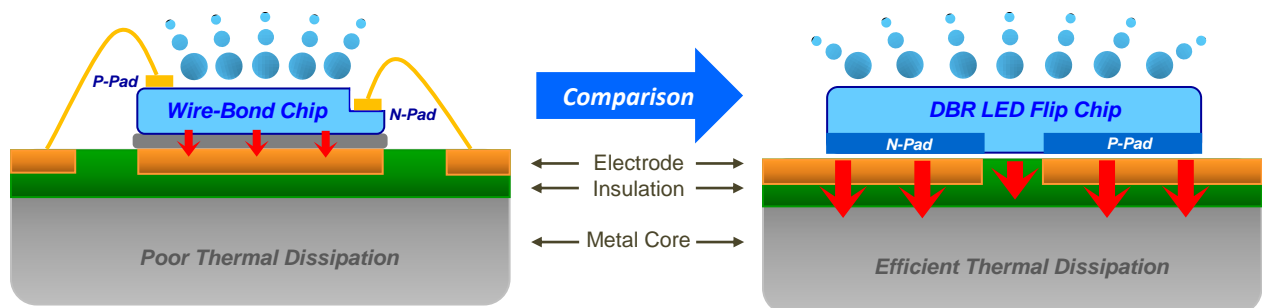

Electro-Optical Characteristics (Red Peak @ 627±2nm, Ta=25°C):

Viewing Angle $2\theta_{1/2} = 140^\circ$

Model	Blue/Red Power Ratio	PPFD ($\mu\text{mole/s}$)			V_F (V) @ $I_F=6.65\text{A}$	LES (mm)
		Total 400nm~700nm	Blue 400nm~500nm	Red 600nm~700nm		
F300.3	1/3	380.8	119.6	235.3	45.1	59
F300.6	1/6	366.9	69.1	268.2		
F300.8	1/8	363.2	55.6	277.0		
F300.10	1/10	360.4	45.5	283.6		
F300.12	1/12	358.6	38.8	288.0		

Emitting Spectrum (Red Peak @ 627±2nm, Ta=25°C):

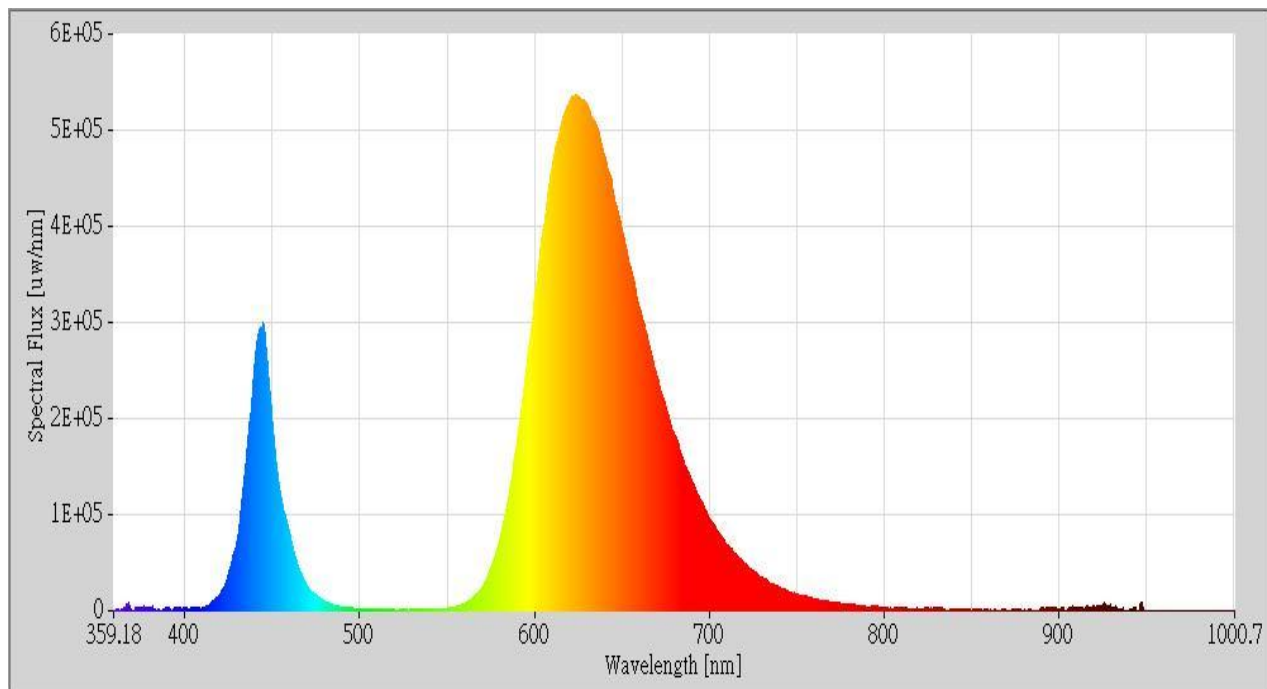

Note: Spectrum referencing from Duet F250.12 @ 180W operation.

Electro-Optical Characteristics (Red Peak @ 640±2nm, Ta=25°C):

Viewing Angle $2\theta_{1/2} = 140^\circ$

Model	Blue/Red Power Ratio	PPFD ($\mu\text{mole/s}$)			V_F (V) @ $I_F=6.65\text{A}$	LES (mm)
		Total 400nm~700nm	Blue 400nm~500nm	Red 600nm~700nm		
F300.3	1/3	360.1	119.6	224.8	45.1	59
F300.6	1/6	343.3	69.1	256.3		
F300.8	1/8	338.8	55.6	264.7		
F300.10	1/10	335.5	45.5	271.0		
F300.12	1/12	333.2	38.8	275.2		

Emitting Spectrum (Red Peak @ 640±2nm, Ta=25°C):

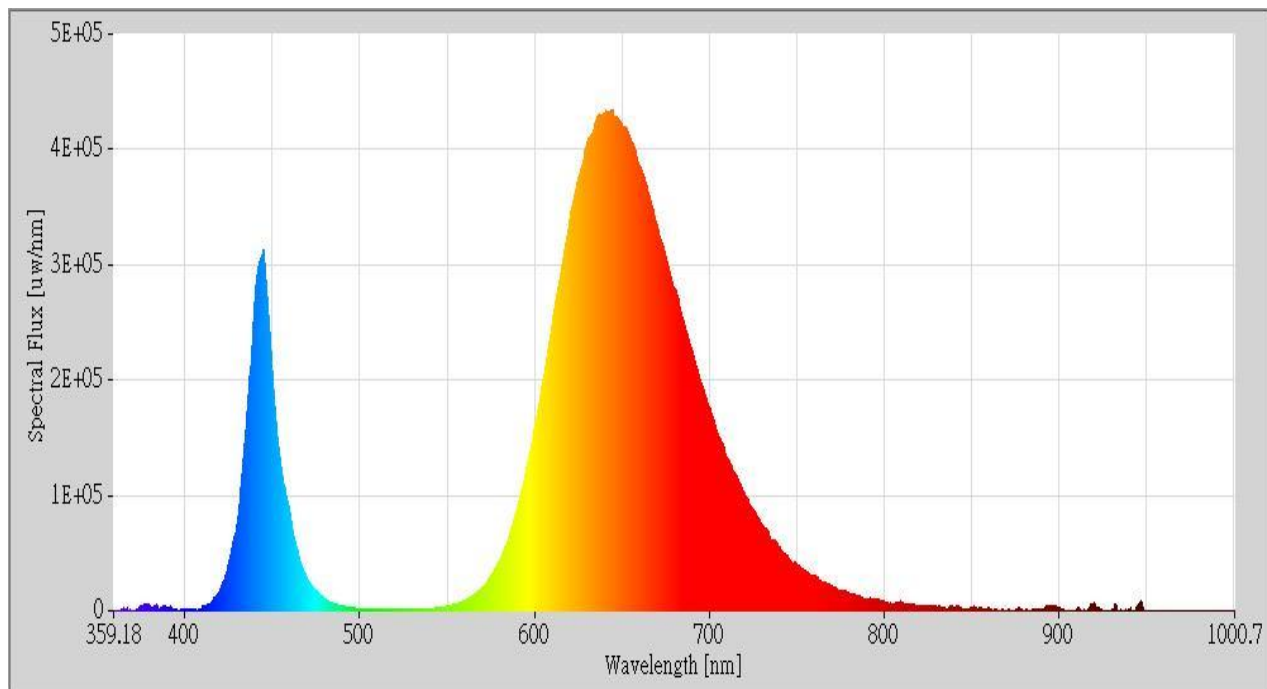

Note: Spectrum referencing from Duet F250.12 @ 180W operation.

Electro-Optical Characteristics (Red Peak @ 650±2nm, Ta=25°C):

Viewing Angle $2\theta_{1/2} = 140^\circ$

Model	Blue/Red Power Ratio	PPFD ($\mu\text{mole/s}$)			V_F (V) @ $I_F=6.65\text{A}$	LES (mm)
		Total 400nm~700nm	Blue 400nm~500nm	Red 600nm~700nm		
F300.3	1/3	322.7	119.6	195.5	45.1	59
F300.6	1/6	300.6	69.1	222.9		
F300.8	1/8	294.8	55.6	230.2		
F300.10	1/10	290.4	45.5	235.7		
F300.12	1/12	287.4	38.8	239.3		

Emitting Spectrum (Red Peak @ 650±2nm, Ta=25°C):

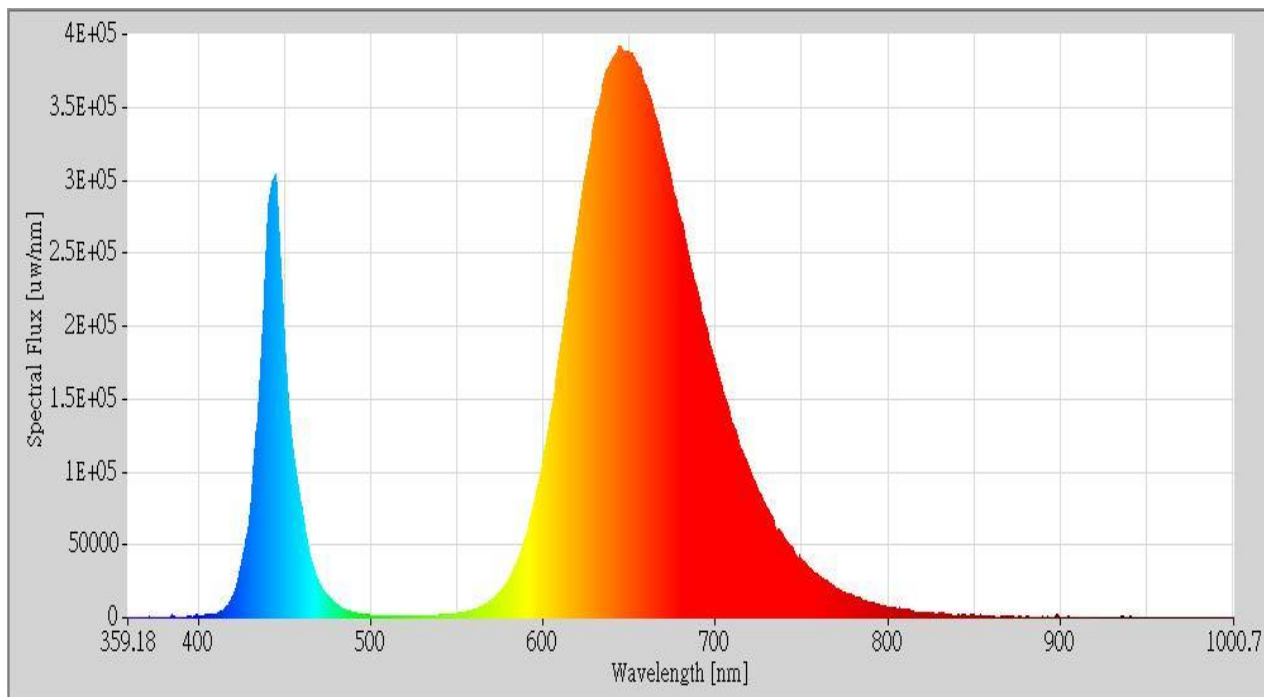

Note: Spectrum referencing from Duet F250.12 @ 180W operation.

Absolute Maximum Ratings (Ta=25°C):

Parameter	Symbol	Max. Rating	Conditions
Power Dissipation	P_d	646.4W	$T_j \leq 140^\circ\text{C}$
DC Forward Current	I_F	13,300mA	$T_j \leq 140^\circ\text{C}$
Junction Temperature	T_j	140°C	
Reverse Voltage	V_r	-5V	$T_{\text{ambient}} = 25^\circ\text{C}$
Reverse Current	I_r	$\leq 1\mu\text{A}$	$V_r = -5\text{V}$
Operating Case Temperature	T_C	-40°C to 105°C	
Storage Temperature	T_{ST}	-40°C to 120°C	

Thermal Characteristics:

Parameter	Symbol	°C/W	Definition
Thermal Resistance	$R_{th(j-b)}$	0.1	Between LED Junction and COB Bottom Surface

- Junction Temperature $T_j = T_b + \text{Power}(W) \times R_{th(j-b)}$, where T_b is the temperature at COB bottom surface.

Circuit Diagram:

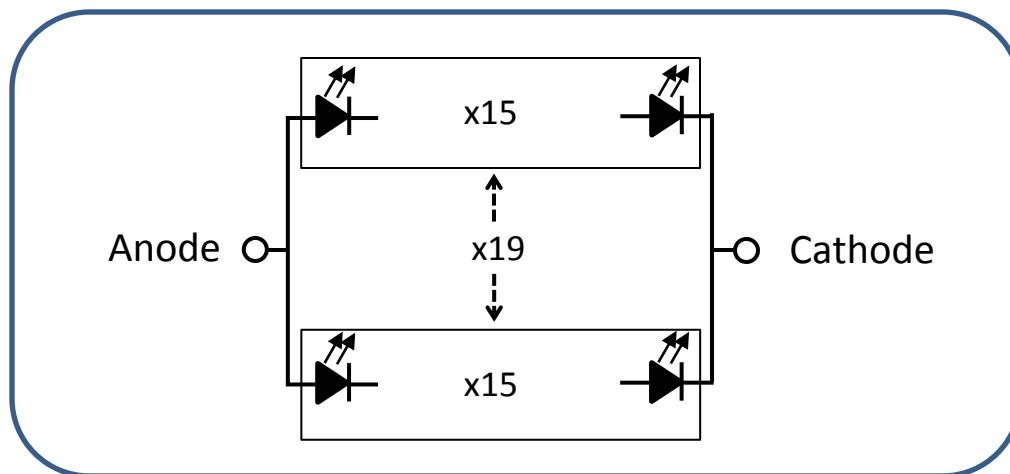

Mechanical Dimensions:

- Solder pads are labeled “+” and “-” to denote positive and negative electrodes, respectively.
- Drawing dimensions are in millimeters, and are not to scale.
- Tolerance: $\pm 0.2\text{mm}$
- The optical center of the LED Array is defined by the mechanical center of the array.

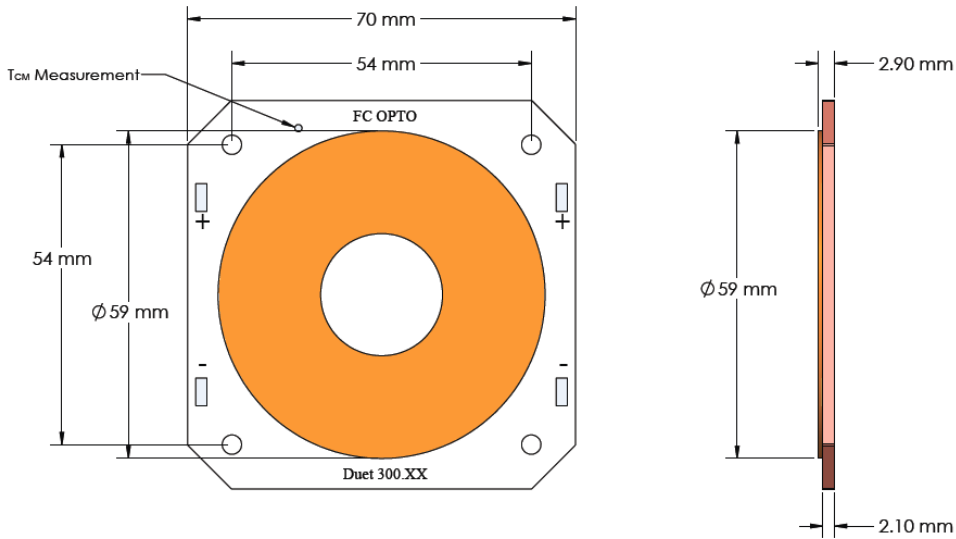

Characteristic Graphs (Ta=25°C):

(i) Typical Forward Current (I_F) vs. Forward Voltage (V_F) of Red Section

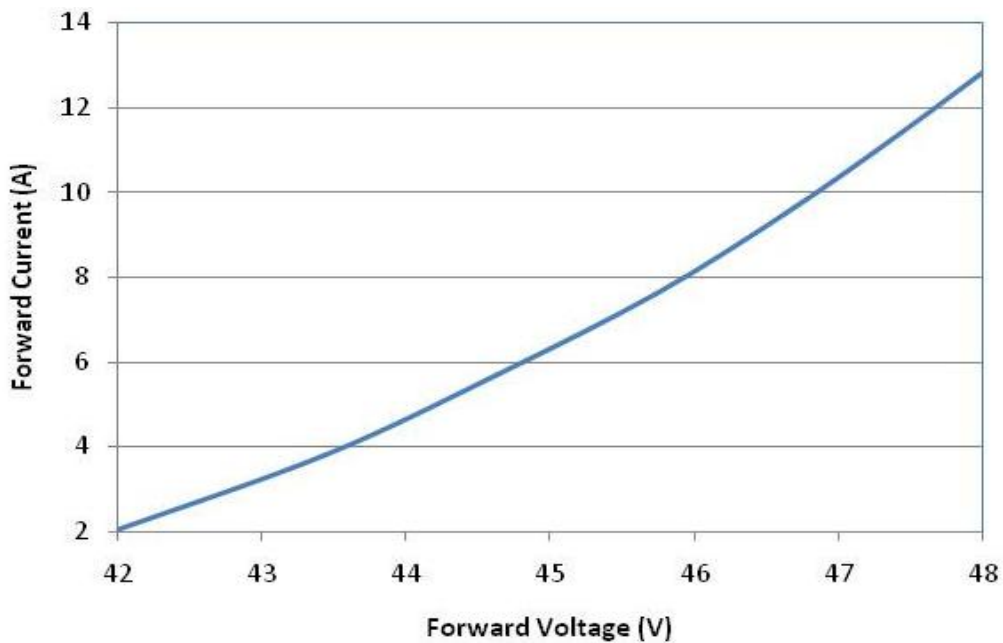

(ii) Typical Spatial Radiation Pattern

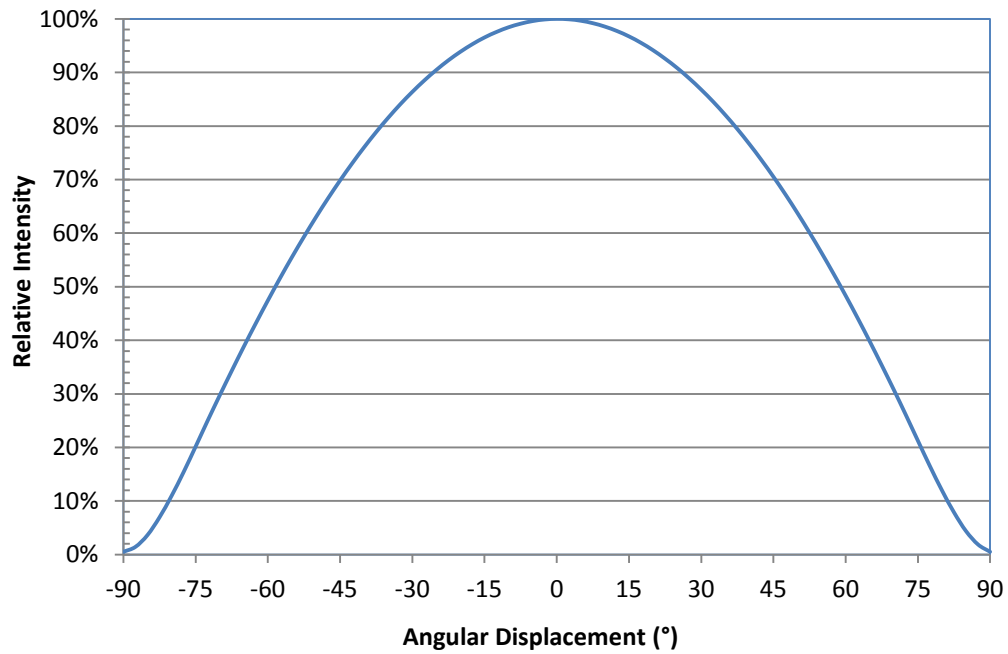

(iii) Typical Polar Radiation Pattern

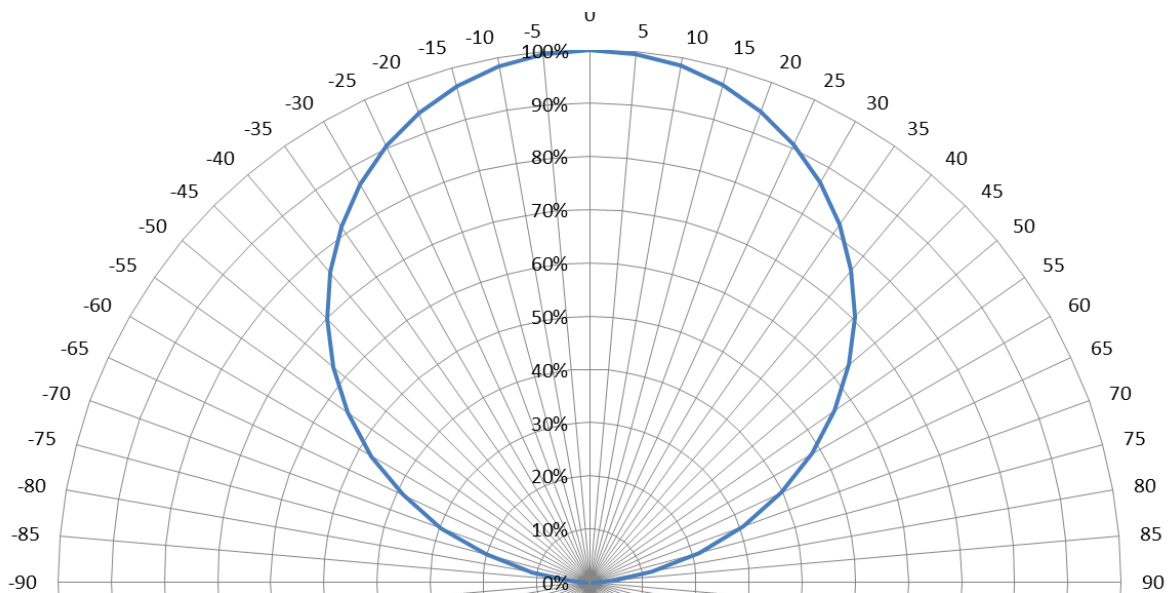

Cautions:

1. Circuit Protection is recommended during the assembly and operation.
 - i. MOV, TVS, current fuse, thermal fuse, capacitor, resistor are options to avoid unexpected circuit faults.

2. Storage Conditions
 - i. Moisture Controlled environment is recommended to avoid COB damages during storage. Moisture may cause circuit damages and result in brightness reduction or failure in circuit contacts.
 - ii. COB in moisture-proof sealed bags should be stored in ambient conditions of temperature less than 30°C and humidity less than 90%RH.
 - iii. COB in open air should be kept in ambient conditions of temperature less than 30°C and humidity less than 60%RH.
 - iv. COB should be restored in moisture-proof bag with moisture absorbent together.

3. Handling Light Emitting Surface (LES)
 - i. LES is a silicone lens and should not have direct contact with sharp tools and human fingers.

4. Recommendation on Assembly with Heat Sink
 - i. Apply thermal grease over the heatsink contact surface to seal the voids and roughness pre-existing on the contact surface.
 - ii. Attach COB onto heatsink contact surface with thermal grease in between. Thermal grease thickness is suggested less than 25um (1 mil)
 - iii. Apply sufficient pressure to secure the COB, and ensure (a) full contact between COB and heatsink, (b) no voids within thermal grease, (c) minimal thermal grease thickness.

5. Flip Chip Opto is not responsible to the damages caused by the operation under the parameters exceeding the values described in the specification.