

Brighter and Cooler

High Efficacy & Lower Thermal Resistance

Luna 100 Chip on Board is a high-performance LED module based on patented **DBR Flip Chips** and unique low temperature bonding technology. The magnitude of the LED illumination is enhanced by the DBR structure to further increase the lighting efficacy. Additionally, the embedment between LED flip chips and MCPCB as well lowers the thermal resistance.

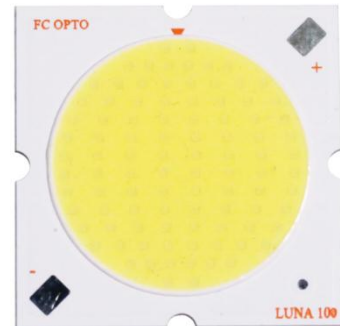

Features:

- Patented DBR Flip Chips
- 217.7W Maximum Power
- Available in 2700K, 3000K, 3200K, 4000K, 5000K, 5600K CCT
- Available in 70-, 80-, 90-, 95- CRI Options
- 30mm Light Emitting Surface
- 0.18°C/W Thermal Resistance
- 35x35mil Flip Chips
- Low Temperature Bonding
- RoHS Compliant

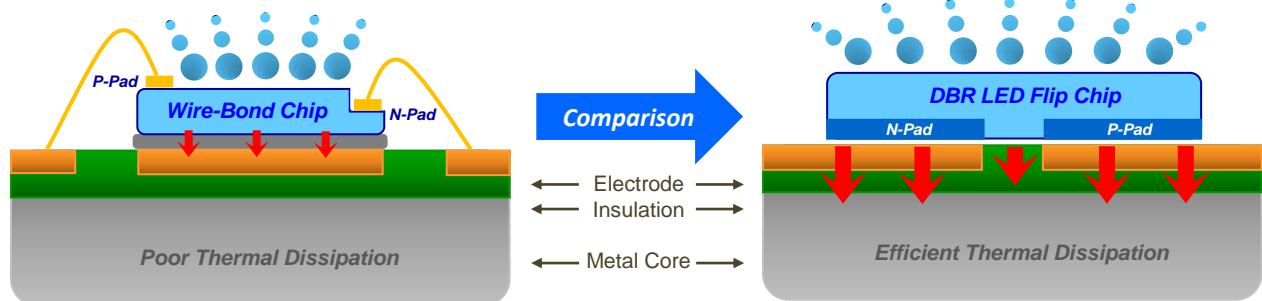

Absolute Maximum Ratings (Ta=25°C):

Parameter	Symbol	Max. Rating	Conditions
Power Dissipation	P_d	217.7W	$T_j \leq 140^\circ\text{C}$
DC Forward Current	I_F	5,600mA	$T_j \leq 140^\circ\text{C}$
Junction Temperature	T_j	140°C	
Reverse Voltage	V_r	-5V	$T_{\text{ambient}} = 25^\circ\text{C}$
Reverse Current	I_r	$\leq 1\mu\text{A}$	$V_r = -5\text{V}$
Operating Case Temperature	T_c	-40°C to 105°C	
Storage Temperature	T_{ST}	-40°C to 120°C	
Soldering Conditions		280°C < 3.5 secs	

*under absolute maximum rated operations - T_c is required to be maintained below 85C in order to achieve minimal degradation in lifespan and performance

Electro-Optical Characteristics (Ta=25°C):

Viewing Angle $2\theta_{1/2} = 140^\circ$

Nominal CCT	Luna Part Number	CRI (min)	Luminous Flux (lm) @ $I_F=2.8\text{A}$	V_F (V) @ $I_F=2.8\text{A}$	Luminous Flux (lm) @ $I_F=5.6\text{A}$	LES (mm)
5000K	100-5070	70	13,770	36.6	22,110	30
5000K	100-5080	80	13,770	36.6	21,445	
4000K	100-4070	70	13,770	36.6	21,480	
3000K	100-3080	80	13,770	36.6	19,466	

Thermal Characteristics:

Parameter	Symbol	°C/W	Definition
Thermal Resistance	$R_{th(j-b)}$	0.18	Between LED Junction and COB Bottom Surface

- Junction Temperature $T_j = T_b + \text{Power(W)} \times R_{th(j-b)}$, where T_b is the temperature at COB bottom surface.

Bins on the ANSI C78 :

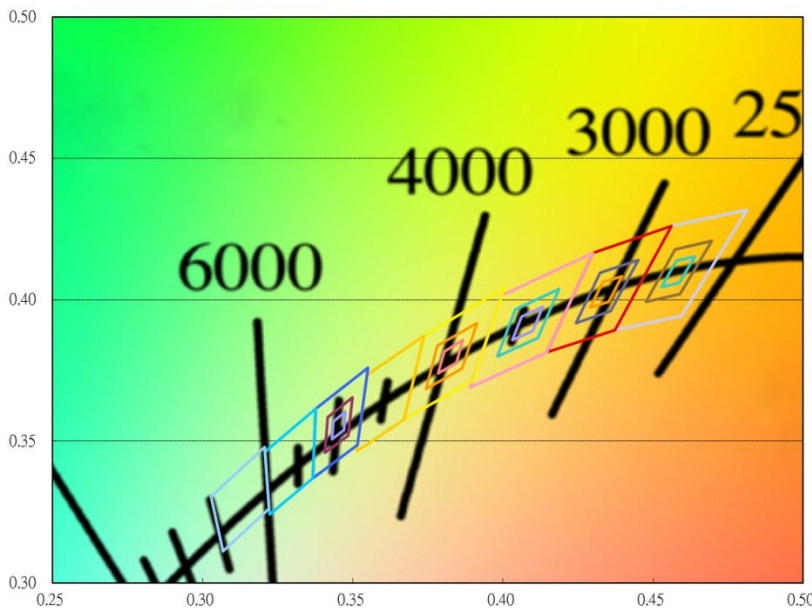

Nominal CCT	x	y
3000K	0.4562	0.4260
	0.4299	0.4165
	0.4147	0.3814
	0.4373	0.3893
4000K	0.4562	0.4260
	0.4006	0.4044
	0.3736	0.3874
	0.3670	0.3578
5000K	0.3898	0.3716
	0.4006	0.4044
	0.3551	0.3760
	0.3376	0.3616
	0.3366	0.3369
	0.3515	0.3487
	0.3551	0.376

Spectrum (Ta=25°C):

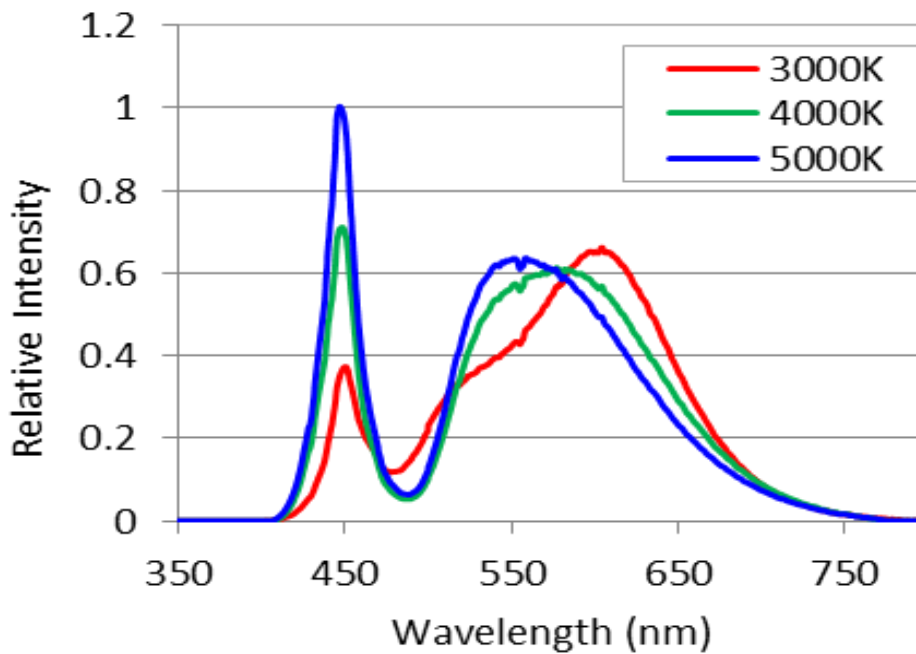

Characteristic Graphs (Ta=25°C):

(i) Typical Forward Current (I_F) vs. Forward Voltage (V_F)

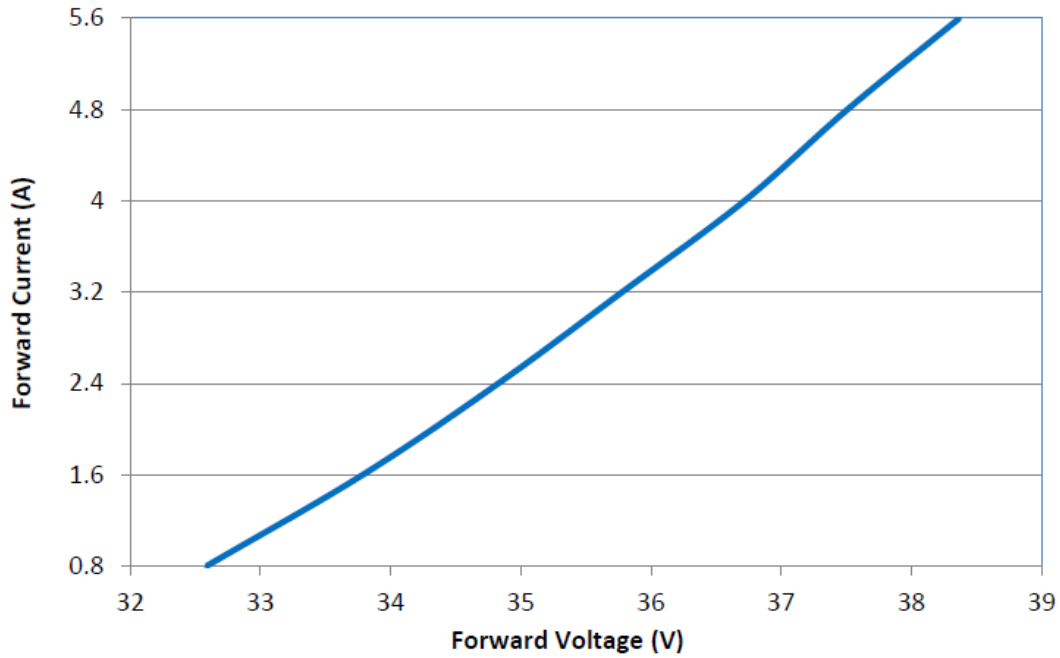

(ii) Typical Normalized Luminous Flux vs. Forward Current (I_F)

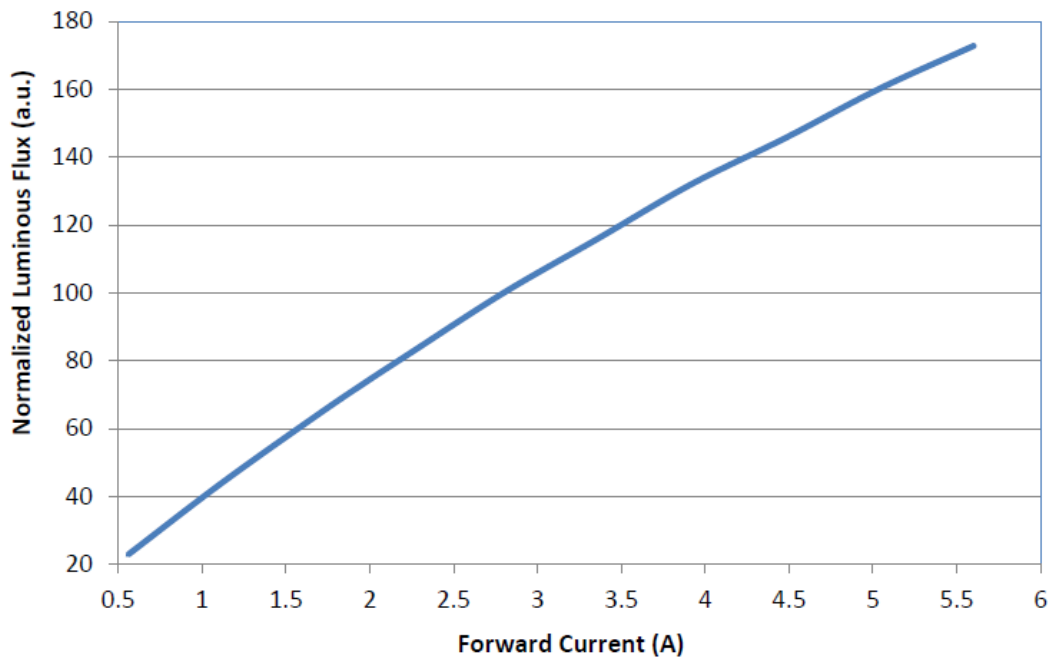

(iii) Typical Spatial Radiation Pattern

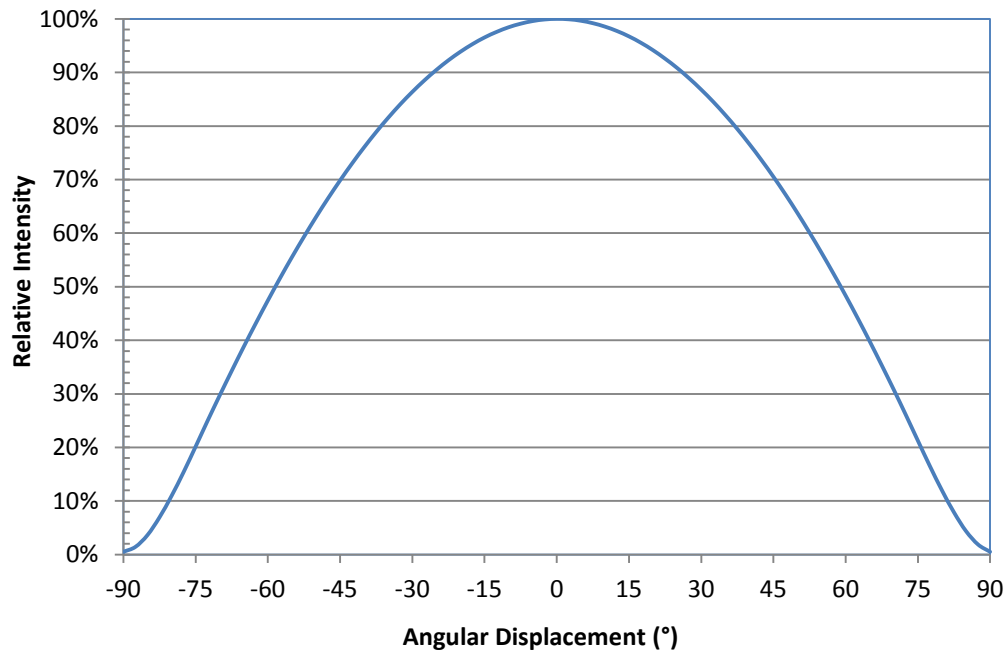

(iv) Typical Polar Radiation Pattern

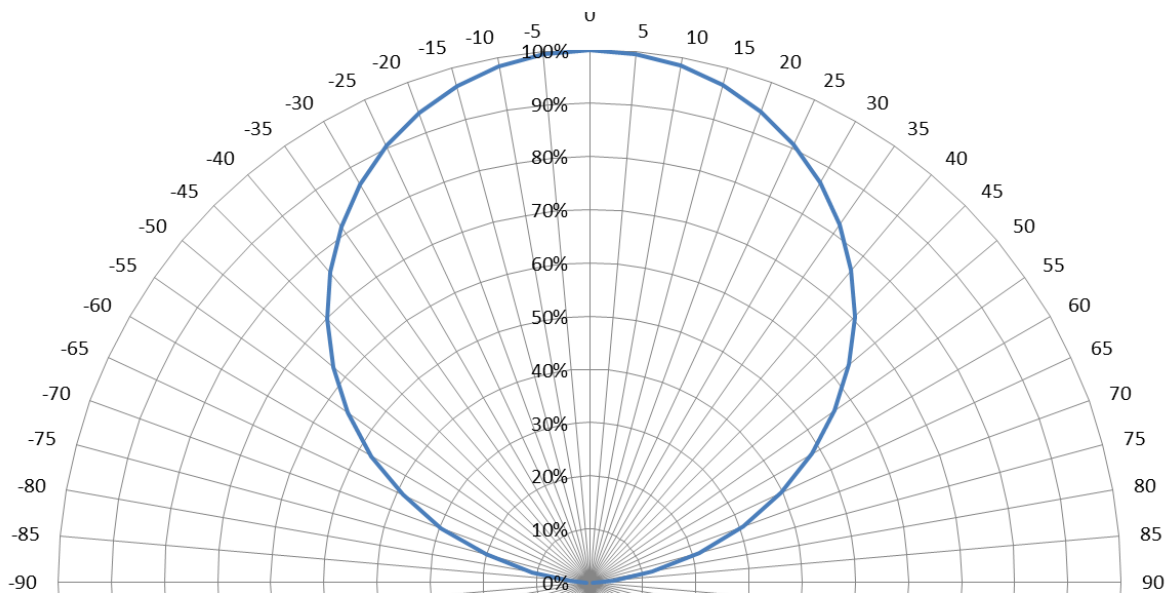

Mechanical Dimensions:

- Solder pads are labeled “+” and “-” to denote positive and negative, respectively.
- Drawing dimensions are in millimeters, and are not to scale.
- Tolerance: $\pm 0.2\text{mm}$
- The optical center of the LED Array is defined by the mechanical center of the array.

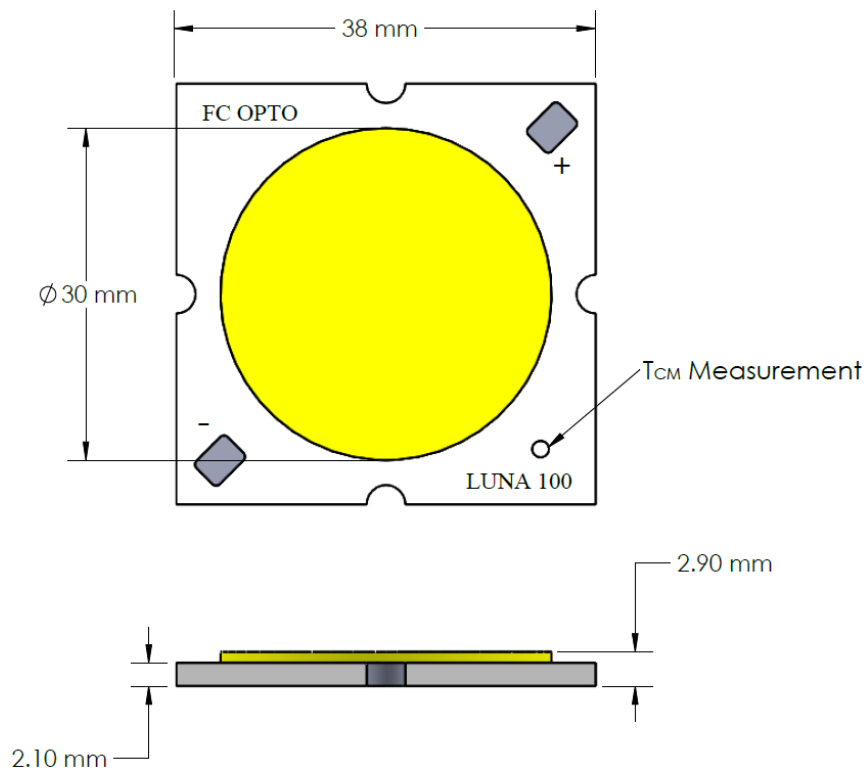

Circuit Diagram:

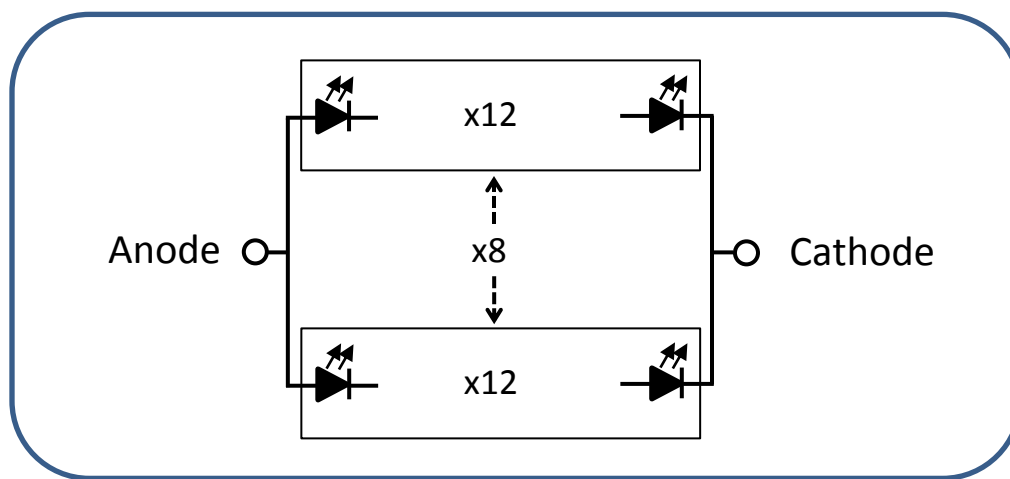

Cautions:

1. Circuit Protection is recommended during the assembly and operation.
 - i. MOV, TVS, current fuse, thermal fuse, capacitor, resistor are options to avoid unexpected circuit faults.

2. Storage Conditions
 - i. Moisture Controlled environment is recommended to avoid COB damages during storage. Moisture may cause circuit damages and result in brightness reduction or failure in circuit contacts.
 - ii. COB in moisture-proof sealed bags should be stored in ambient conditions of temperature less than 30°C and humidity less than 90%RH.
 - iii. COB in open air should be kept in ambient conditions of temperature less than 30°C and humidity less than 60%RH.
 - iv. COB should be restored in moisture-proof bag with moisture absorbent together.

3. Handling Light Emitting Surface (LES)
 - i. LES is a silicone lens and should not have direct contact with sharp tools and human fingers.

4. Recommendation on Assembly with Heat Sink
 - i. Apply thermal grease over the heatsink contact surface to seal the voids and roughness pre-existing on the contact surface.
 - ii. Attach COB onto heatsink contact surface with thermal grease in between. Thermal grease thickness is suggested less than 25um (1 mil)
 - iii. Apply sufficient pressure to secure the COB, and ensure (a) full contact between COB and heatsink, (b) no voids within thermal grease, (c) minimal thermal grease thickness.

5. Flip Chip Opto is not responsible to the damages caused by the operation under the parameters exceeding the values described in the specification.